

D700+ LED downlight

Datasheet



Product codes

Unit:	Series:	Colour temp. (K):	Beam angle (°):	Colour:
D700+	CR	1.8K.3.1K	20	B (Black)
		2.7K	35	W (White)
		3K	55	
		4K		

Photometrics

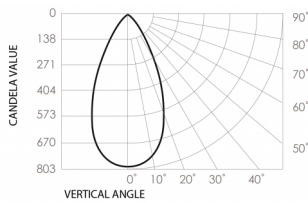

Source lumen output: 680lm
 Delivered lumen: 570lm
 Efficacy: 54lm/W
 Colour temp.: 1.8K-3.1K
 (Night Shift)
 Beam angle: 55°

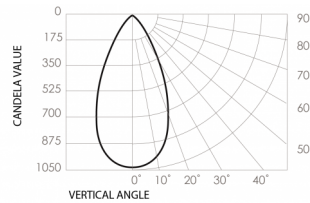

Source lumen output: 1000lm
 Delivered lumen: 745lm
 Efficacy: 70lm/W
 Colour temp.: 4000K
 Beam angle: 55°

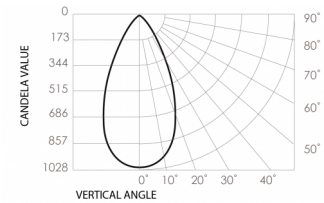

Source lumen output: 980lm
 Delivered lumen: 730lm
 Efficacy: 69lm/W
 Colour temp.: 3000K
 Beam angle: 55°

Dimensions (mm)

Front view

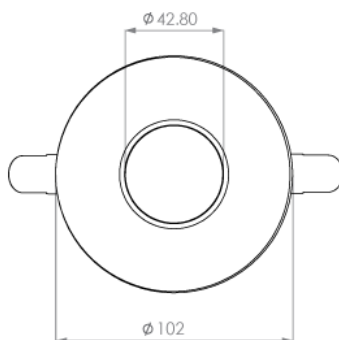

Side view

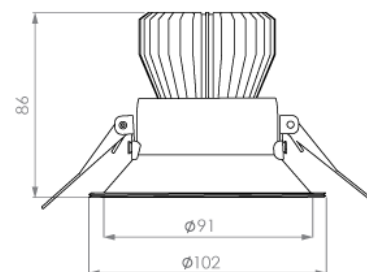

Electrical

Input voltage: 220-240V	Power usage: 10.6W	Driver power factor: 0.9	IP rating: IP44	Surge protection: Yes
Cable length: 1.2m	Dimmable: Yes	Driver: BG-010BSD-235mA		

Operational

Average temp.: 65°C	Ambient temp.: -28 to 60°C	Lifetime: 70,000 hrs (@TA25)	Thermal rating: IC	Source Lumens: 980lm or 1000lm or 680lm or 785lm
-------------------------------	--------------------------------------	--	------------------------------	---

Physical

Weight: 490g	Gimbal angle: 17° Universal	Warranty: 7 years
------------------------	---------------------------------------	-----------------------------

Compatibility

Recommended Dimmers:
Compatible with leading home automation systems and dimmers.
Recommended Dimmers:
Universal, Trailing Edge, Leading Edge.
Dali option available on request.

*For more details please refer to:
<https://brightgreen.com/digital-driver>
All systems are unique, please
call 1300 672 499 for advice on your installation.

Installation



Step 1
Using a 92mm hole saw, cut a hole in the ceiling at the desired location.

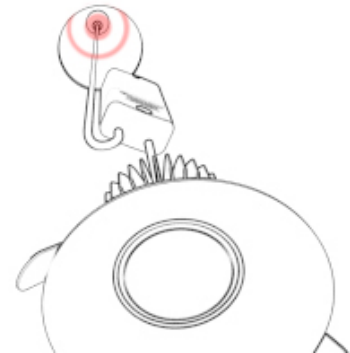

Step 2
Plug the driver into a mounted general power outlet (GPO) in the ceiling. This luminaire can be covered and abutted with insulation.

Installation

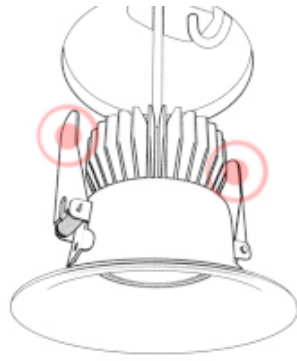

Step 3
Pull back the springs and insert the luminaire into the ceiling cavity.

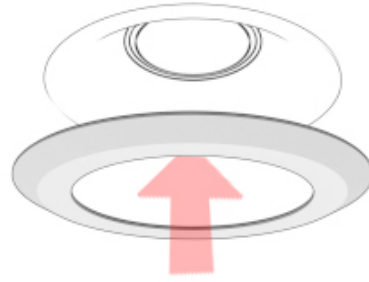

Step 4
For installation with a fascia, align the luminaire with the fascia and screw clockwise until firmly in place.

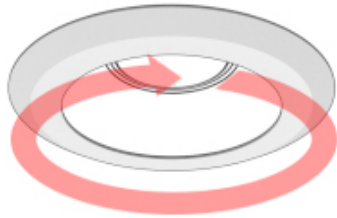

Step 5
Thread the fascia clockwise until firmly in place.
Installation complete.