

D900.SHX Linear LED downlight

Datasheet

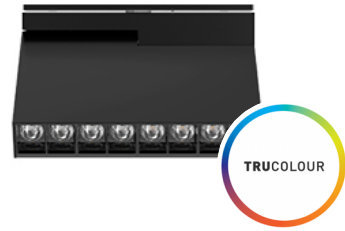

Product codes

Unit: D900.SHX	Series: LN	Colour temp.: 2.7K (Special Order) 3K 4K 5K (Special Order)	Beam angle (°): 10 40	Colour: B (Black) W (White)
--------------------------	----------------------	--	------------------------------------	--

Photometrics

Standard Products

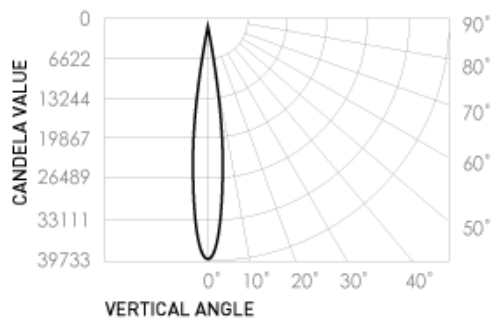

Source lumen output: 1255lm
 Delivered lumen: 950lm
 Efficacy: 59lm/W
 Colour temp.: 3000K
 Beam angle: 10°

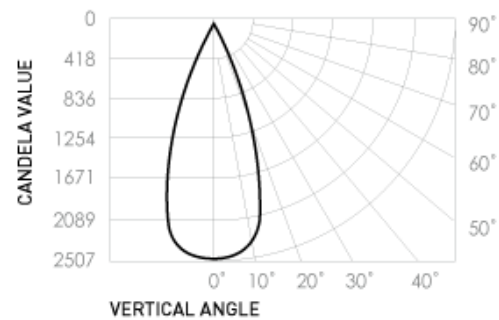

Source lumen output: 1255lm
 Delivered lumen: 950lm
 Efficacy: 59lm/W
 Colour temp.: 3000K
 Beam angle: 40°

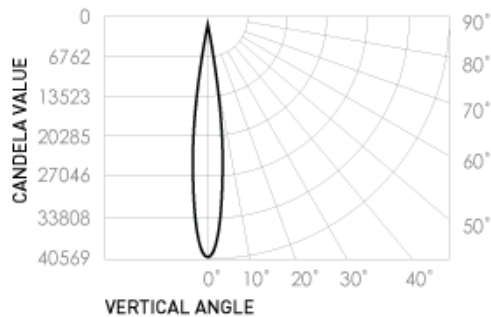

Source lumen output: 1280lm
 Delivered lumen: 970lm
 Efficacy: 61lm/W
 Colour temp.: 4000K
 Beam angle: 10°

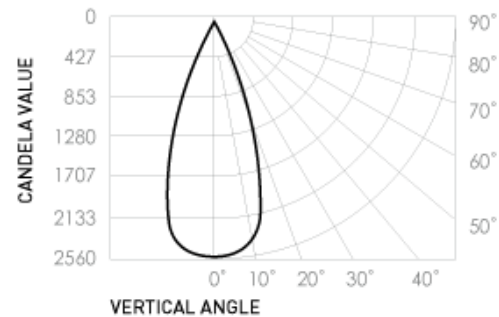

Source lumen output: 1280lm
 Delivered lumen: 970lm
 Efficacy: 61lm/W
 Colour temp.: 4000K
 Beam angle: 40°

Special Order Products

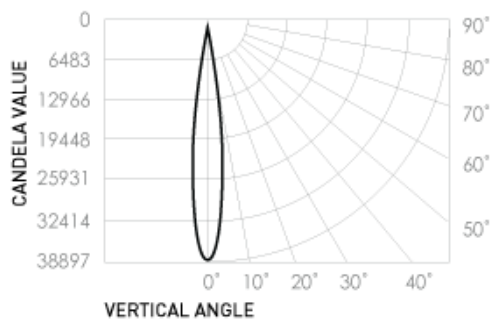

Source lumen output: 1230lm
 Delivered lumen: 930lm
 Efficacy: 58lm/W
 Colour temp.: 2700K (Special Order)
 Beam angle: 10°

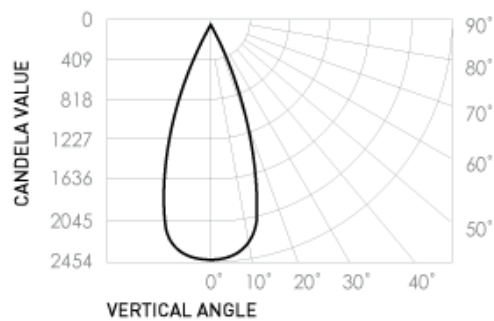

Source lumen output: 1230lm
 Delivered lumen: 930lm
 Efficacy: 58lm/W
 Colour temp.: 2700K (Special Order)
 Beam angle: 40°

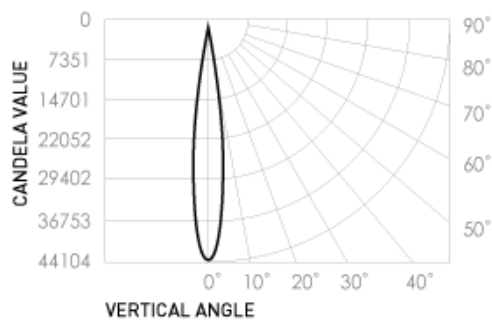

Source lumen output: 1395lm
 Delivered lumen: 1055lm
 Efficacy: 66lm/W
 Colour temp.: 5000K (Special Order)
 Beam angle: 10°

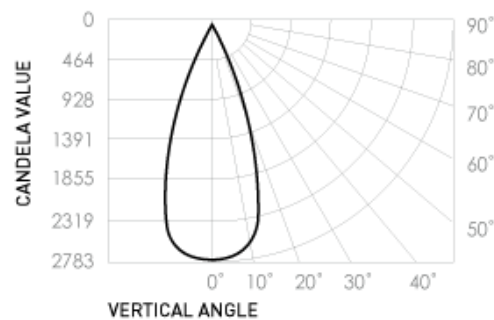

Source lumen output: 1395lm
 Delivered lumen: 1055lm
 Efficacy: 66lm/W
 Colour temp.: 5000K (Special Order)
 Beam angle: 40°

Dimensions (mm)

Front view

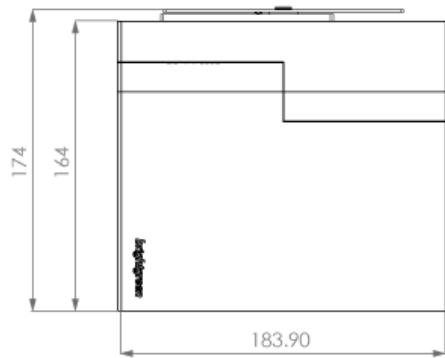

Side view



Electrical

Input voltage: 220-270V	Power usage: 16W	Driver power factor: >0.9	IP rating: IP44	Surge protection: 3100V
Dimmable: Yes	Driver: BG-017BSD-600mA			

Operational

Operating temp.: -30 to 85°C	Average temp.: 60°C	Ambient temp.: -28 to 50°C	Lifetime L70, B10: 50,000 hrs (@TA25)	Source Lumens: 1255lm or 1280lm or 1230lm or 1395lm
--	-------------------------------	--------------------------------------	---	--

Physical

Gimbal angle: 90°/360°	Warranty: 7 years
----------------------------------	-----------------------------

Compatibility

Recommended Dimmers:
"Compatible with leading home automation systems and dimmers.
Recommended Dimmers:
Universal, Trailing Edge, Leading Edge.

*For more details please refer to:
<https://brightgreen.com/digital-driver>
All systems are unique, please
call 1300 672 499 for advice on your installation."

Installation

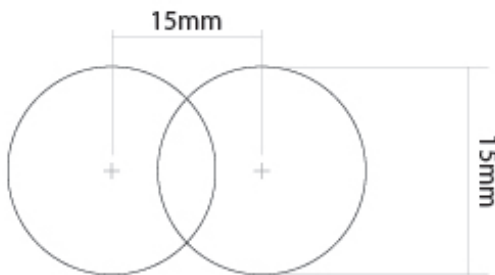

Step 1

Using a 20mm hole saw, cut two holes in the ceiling with the centre points 15mm apart at the desired location.

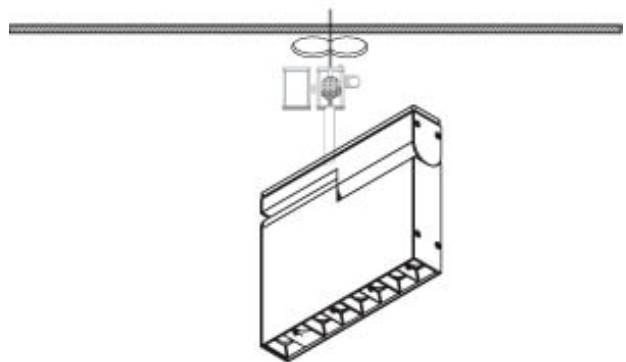

Step 2

Thread the power cable through the ceiling. Open the junction box and connect the power cable. Reattach the cover of the junction box and return it into the ceiling.

Installation

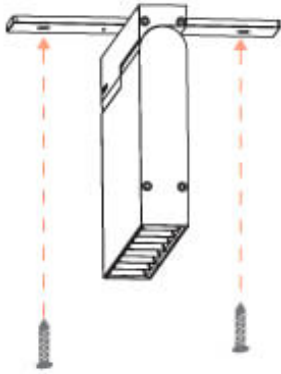

Step 3
Mount the unit to the ceiling using the 2 screws provided.

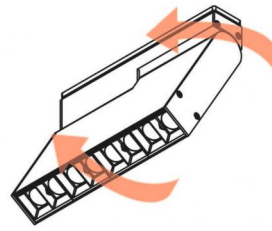

Step 4
Once the light is installed, orient the luminaire to focus the light as required.