

W900 Cube LED wall light

Datasheet



Product codes

Unit: W900	Series: CB	Colour temp.: 3K	Beam angle (°): 90/75	Colour: S (Silver) W (White)
----------------------	----------------------	----------------------------	---------------------------------	---

Photometrics

Standard Products

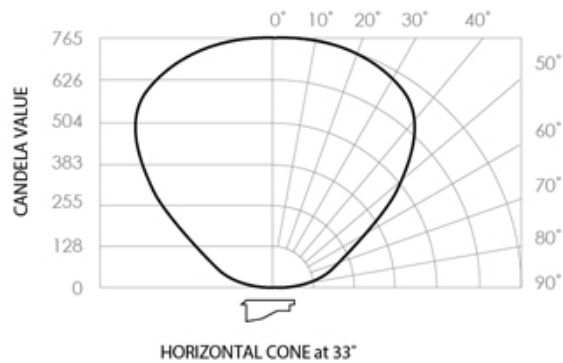

Source lumen output: 1020lm

Delivered lumen: 900lm

Efficacy: 50lm/W

Colour temp.: 3000K

Beam angle: 90/75°

Dimensions (mm)

Front view

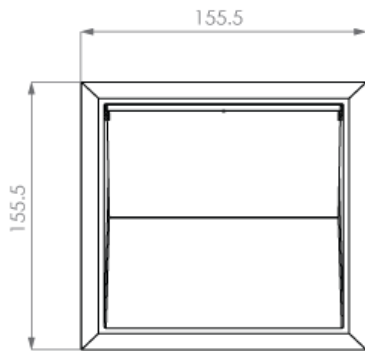

Side view

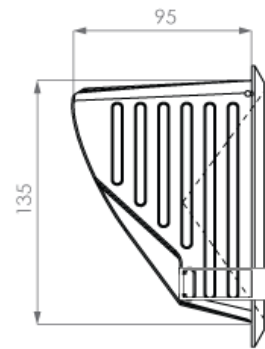

Electrical

Input voltage: 220-240V	Power usage: 18W	Driver power factor: >0.98	IP rating: IP43	Surge protection: 3100V
AC Cable length: 1.5m	Dimmable: Yes	Driver: BG-005BSD-400mA	DC Cable Length: 0.3m	

Operational

Operating temp.: -30 to 85°C	Average temp.: 56°C	Ambient temp.: -28 to 65°C	Lifetime L70, B10: 70,000 hrs (@TA25)	Source Lumens: 1020lm
--	-------------------------------	--------------------------------------	---	---------------------------------

Physical

Weight: 925g	Gimbal angle: N/A	Warranty: 7 years
------------------------	-----------------------------	-----------------------------

Compatibility

Recommended Dimmers:

"Compatible with leading home automation systems and dimmers.

Recommended Dimmers:

Universal, Trailing Edge, Leading Edge.

Dali option available on request

*For more details please refer to:

<https://brightgreen.com/digital-driver>

All systems are unique, please

call 1300 672 499 for advice on your installation."

Installation

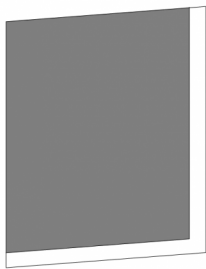

Step 1

Using a router or jigsaw, cut a 138x138mm hole in the ceiling at the desired location.

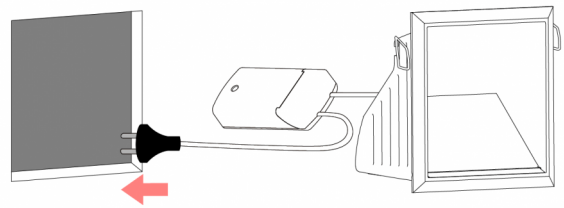

Step 2

Plug the driver into a mounted general power outlet (GPO) in the wall.

Installation

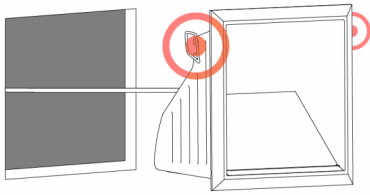

Step 3

Pull back the springs and insert the luminaire into the wall cavity. This luminaire can be covered and abutted with insulation.

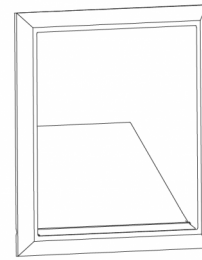

Step 4

Once the light is installed, orient the luminaire using its paddle diffuser to focus the light as required.